

# altimo

## User Manual



Table top freezer  
**ATTFZ4442W**

# Content

Safety Information	Page 1-7
Overview	Page 8
Reverse door	Page 9-11
Installation	Page 12-13
Daily use	Page 14-15
Troubleshooting	Page 16
Hints and tips	Page 17-18
Product fiche	Page 19
Help & assistance	Page 20
Your appliance guarantee	Page 21

## **Safety Information**



To ensure your safety and the proper use of this appliance, please read this user manual thoroughly, including all hints and warnings, before installation and initial use. Familiarising all users with the operation and safety features of the appliance is vital to prevent unnecessary errors and accidents. Retain these instructions and ensure they accompany the appliance if it is relocated or sold, allowing future users to be well-informed about its operation and safety protocols. Adhering to the precautions outlined in this manual is crucial, as the manufacturer cannot be held liable for damages resulting from negligence.

- Safety Guidelines for Children and Vulnerable Individuals
- This appliance may be used by children aged 8 years and older, as well as individuals with reduced physical, sensory, or mental capabilities, provided they have received supervision or instruction regarding safe usage and understand the associated hazards.
- Children aged 3 to 8 years are permitted to load and unload the appliance.
- Adult supervision is necessary to ensure that children do not engage in play with the appliance.
- Cleaning and maintenance should only be performed by children aged 8 and above, under supervision.
- Keep all packaging materials away from children to prevent the risk of suffocation.







When disposing of the appliance, please unplug it from the socket, cut the power cord as close to the appliance as possible, and remove the door to prevent potential electric shock or entrapment hazards for children.

If this appliance, which features magnetic door seals, is replacing an older model with a spring lock (latch) on the door or lid, ensure that the spring lock is rendered unusable prior to disposal to prevent it from becoming a dangerous entrapment risk for children.

# Safety Information



## General Safety Precautions

-  **WARNING!** Ensure that ventilation openings in the appliance enclosure or built-in structure remain unobstructed.
-  **WARNING!** Do not utilise mechanical devices or any means to expedite the defrosting process, except those specifically recommended by the manufacturer.
-  **WARNING!** Avoid damaging the refrigerant circuit.
-  **WARNING!** Refrain from using other electrical appliances (such as ice cream makers) inside the refrigerating appliance unless they have been approved for this purpose by the manufacturer.
-  **WARNING!** Do not touch the light bulb if it has been on for an extended period, as it may be very hot.\*
-  **WARNING!** When positioning the appliance, ensure that the supply cord is neither trapped nor damaged.
-  **WARNING!** Do not place multiple portable socket outlets or power supply units at the rear of the appliance.

\*Applicable only if there is a light in the compartment.

## Safety Information



- Do not store explosive substances, such as aerosol cans containing flammable propellants, in this appliance.
- The refrigerant isobutane (R-600a) is utilized within the refrigerant circuit of this appliance. While it is a natural gas with a high level of environmental compatibility, it is also flammable.
- During the transportation and installation of the appliance, ensure that none of the components of the refrigerant circuit are damaged.
  - Avoid open flames and sources of ignition.
  - Ensure thorough ventilation in the room where the appliance is located.
- It is hazardous to alter the specifications or modify this product in any way. Damage to the cord may result in a short circuit, fire, and/or electric shock.

This appliance is designed for use in household and similar applications, including:

- Staff kitchen areas in shops, offices, and other work environments;
- Farmhouses and by clients in hotels, motels, and other residential-type settings;
- Bed and breakfast establishments; Catering and similar non-retail applications.

 **WARNING!** All electrical components (including the plug, power cord, and compressor) must be replaced exclusively by a certified service agent or qualified personnel.

 **WARNING!** The light bulb provided with this appliance is a "special use lamp," designed solely for use with this appliance and not suitable for general domestic lighting.\*

- The power cord must not be extended.
- Ensure that the power plug is not pinched or damaged by the rear of the appliance, as this may lead to overheating and pose a fire hazard.
- Confirm that you have access to the mains plug of the appliance.
- Do not pull on the mains cable.
- If the power socket is loose, do not insert the power plug, as this presents a risk of electric shock or fire.
- The appliance must not be operated without the lamp installed.
- This appliance is heavy; exercise caution when moving it.
- Avoid removing or touching items from the freezer compartment with damp or wet hands to prevent skin abrasions or frostbite.
- Minimise prolonged exposure of the appliance to direct sunlight.

\*Applicable only if there is a light in the compartment.

## Daily Use Guidelines

- Avoid placing hot items on the plastic components of the appliance.
- Do not position food products directly against the rear wall.
- Frozen food should not be re-frozen once it has been thawed.
- Store pre-packaged frozen food according to the manufacturer's instructions.
- Strictly adhere to the storage recommendations provided by the appliance's manufacturer.
- Refer to the relevant instructions for specific guidance.
- Do not place carbonated or fizzy drinks in the freezer compartment, as this can create pressure in the container, potentially leading to an explosion and damage to the appliance.
- Ice lollies can cause frostbite if consumed immediately after removal from the appliance.
- To prevent food contamination, please follow these instructions:
  - Avoid leaving the door open for extended periods, as this can significantly raise the temperature within the appliance compartments.
  - Regularly clean surfaces that come into contact with food, as well as accessible drainage systems.
  - Clean water tanks that have been unused for 48 hours; flush the water system connected to a water supply if water has not been drawn for five days.
  - Store raw meat and fish in suitable containers within the refrigerator to prevent contact with or dripping onto other foods.
  - Two-star frozen-food compartments (if present in the appliance) are suitable for storing pre-frozen food, making ice cream, and creating ice cubes.

\*Applicable only if the appliance includes a freezer compartment.

## Care and Cleaning

- Prior to maintenance, ensure the appliance is switched off and disconnect the mains plug from the socket.
- Avoid using metal objects for cleaning the appliance.
- Refrain from using sharp instruments to remove frost; instead, utilise a plastic scraper.

Regularly inspect the drain in the refrigerator for defrosted water. If necessary, clean the drain; a blockage may cause water to accumulate at the bottom of the appliance.

## Installation

**Important:** For electrical connections, carefully adhere to the instructions provided in the designated sections.

Unpack the appliance and inspect it for any damages. If the appliance is damaged, do not connect it and report the issue immediately to the retailer, retaining the original packaging.

- It is advisable to wait at least four hours before connecting the appliance to allow the oil to return to the compressor.
- Ensure adequate air circulation around the appliance; insufficient ventilation can lead to overheating. Follow the installation instructions to promote sufficient airflow.
- Whenever possible, position the spacers against a wall to prevent contact with warm components (compressor, condenser) and reduce the risk of burns.
- The appliance should not be situated near radiators or stoves.
- Confirm that the mains plug remains accessible after installation.
- Note that one, two, and three-star compartments (if present in the appliance) are not suitable for freezing fresh food.

If the appliance will be left empty for extended periods, switch it off, defrost it, clean and dry it, and leave the door open to prevent mold growth.

## **Service**

- Any electrical work required to do the servicing of the appliance should be carried out by a qualified electrician or competent person.
- This product must be serviced by an authorized Service Center, and only genuine spare parts must be used.

## **Energy Saving**

- Don't put hot food in the appliance;
- Don't pack food close together as this prevents air circulating;
- Make sure food don't touch the back of the compartment(s);
- If electricity goes off, don't open the door(s);
- Don't open the door(s) frequently;
- Don't keep the door(s) open for too long time;
- Don't set the thermostat on exceeding cold temperatures;
- All accessories, such as drawers, shelves
- balconies, should be kept there for lower energy consumption

## Safety Information



### Environment Protection



This appliance does not contain gasses which could damage the ozone layer, in either its refrigerant circuit or insulation materials. The appliance shall not be discarded together with the urban refuse and rubbish. The insulation foam contains flammable gases: the appliance shall be disposed according to the appliance regulations to obtain from your local authorities. Avoid damaging the cooling unit, especially the heat exchanger. The materials used on this appliance marked by the symbol are recyclable.



The symbol on the product or on its packaging indicates that this product may not be treated as household waste. Instead it should be taken to the appropriate collection point for the recycling of electrical and electronic equipment. By ensuring this product is disposed of correctly, you will help prevent potential negative consequences for the environment and human health, which could otherwise be caused by inappropriate waste handling of this product. For more detailed information about recycling of this product, please contact your local council, your household waste disposal service or the shop where you purchased the product.

### Disposal of the appliance

1. Disconnect the mains plug from the mains socket.
2. Cut off the mains cable and discard it.



**⚠ WARNING!** During using, service and disposal the appliance, please pay attention to symbol similar as left side, which is located on rear of appliance (rear panel or compressor) and with yellow or orange color. It's risk of fire warning symbol. There are flammable materials in refrigerant pipes and compressor. Please be far away fire source during using, service and disposal.

# Overview

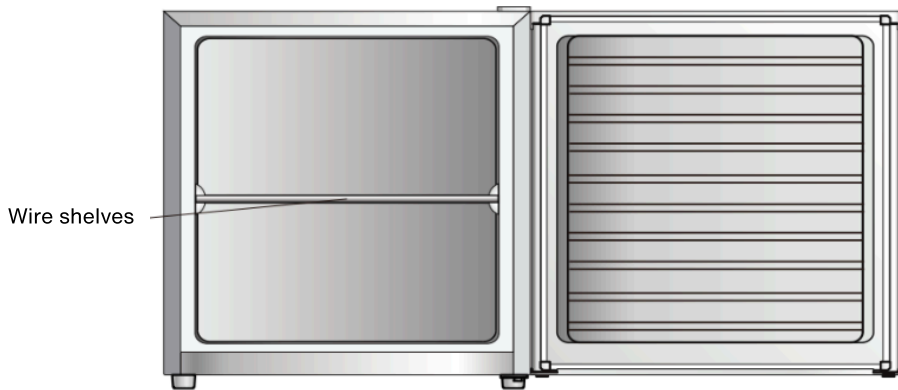

Thermostat

Leveling feet

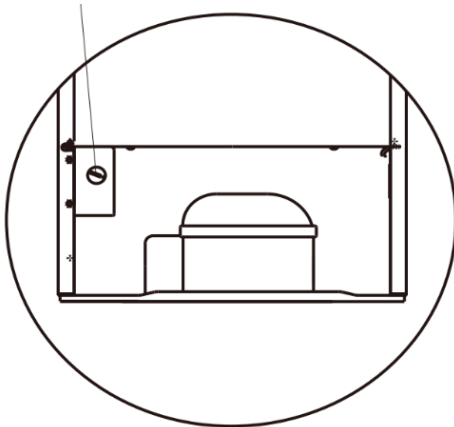

*Note: This is an overview image is for guidance only. For accurate detail please check your appliance.*

# Reverse door

## Tools required:

- Philips screwdriver
  - Flat bladed screwdriver
  - Hexagonal spanner.
- Ensure the unit is unplugged and empty.
  - To take the door off, it is necessary to tilt the unit backwards. You should rest the unit on something solid so that it will not slip during the door reversing process.
  - All parts removed must be saved to do the reinstallation of the door.
  - Do not lay the unit flat as this may damage the cooling system.
  - It's better that 2 people handle the unit during assembly.

1. Remove two screws at rear side of top cover

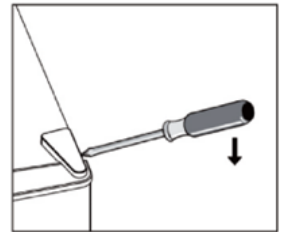

2. Remove top cover on both sides and place it aside.

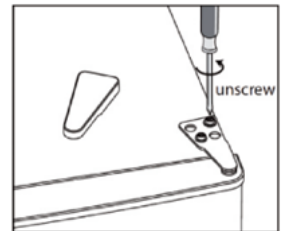

3. Move the top cover from left side to right side. And then lift the upper door and place it on a padded surface to prevent it from scratching.

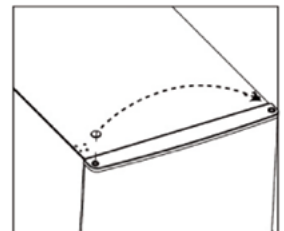

# Reverse door

- 4. Unscrew and remove the bottom hinge pin, turn the bracket over and replace it.

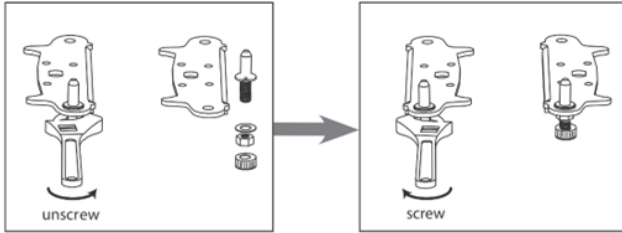

- 5. Refit the bracket fitting the bottom hinge pin. Replace both adjustable feet.

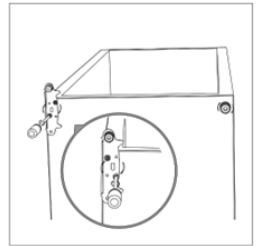

- 6. Detach the door gasket and the attach it after rotating.

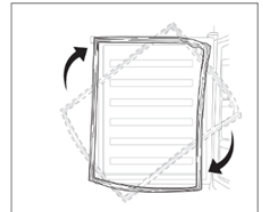

- 7. Place the door back on. Ensure the door is aligned horizontally and vertically so that the seals are closed on all sides before finally tightening the top hinge.

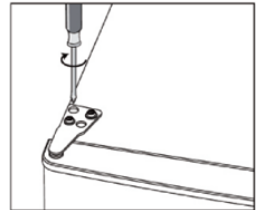

- 8. Insert the hinge bracket and screw it to the top of the unit

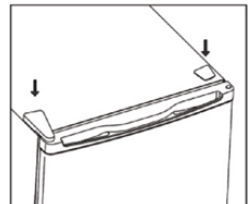

## Reverse door

9. Use a spanner to tighten it if necessary.
10. Put the hinge cover and the screw cover back.
11. With the door closed, check that the door is aligned horizontally and vertically and that the seals are closed on all sides before finally tightening the bottom hinge. Re-adjust the levelling feet as needed.

**Install door external handle** (if external handle is present)

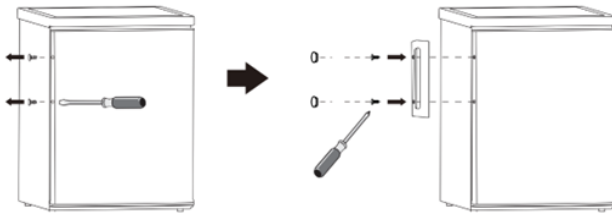

# Installation

## Space Requirement

- Keep enough space for door open.
- Keep at least 50mm gap at two sides and back.

Note: this refrigerating appliance is not intended to be used as a built-in appliance

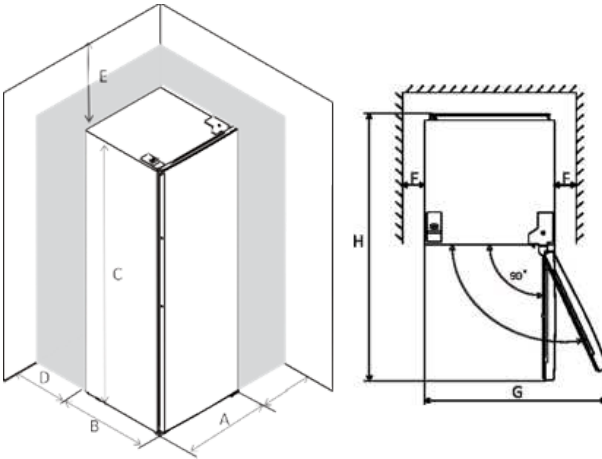

A	550
B	580
C	850
D	min=50
E	min=50
F	min=50
G	1100
H	1130

## Levelling unit

To do this, adjust the two levelling feet in front of the unit. If the unit is not level, the doors and magnetic seal alignments will not be covered properly.



# Installation

## Positioning

Install this appliance at a location where the ambient temperature corresponds to the climate class indicated on the rating plate of appliance:

For refrigerating appliances with climate class:

- extended temperate: this refrigerating appliance is intended to be used at ambient temperatures ranging from 10°C to 32 °C; (SN)
- temperate: this refrigerating appliance is intended to be used at ambient temperatures ranging from 16°C to 32 °C; (N)
- subtropical: this refrigerating appliance is intended to be used at ambient temperatures ranging from 16°C to 38 °C; (ST)
- tropical: this refrigerating appliance is intended to be used at ambient temperatures ranging from 16°C to 43 °C; (T)

## Location

The appliance should be installed well away from sources of heat such as radiators, boilers, direct sunlight etc. Ensure that air can circulate freely around the back of the cabinet. To ensure best performance, if the appliance is positioned below an overhanging wall unit, the minimum distance between the top of the cabinet and the wall unit must be at least 50mm. Ideally, however, the appliance should not be positioned below overhanging wall units. Accurate leveling is ensured by one or more adjustable feet at the base of the cabinet. This refrigerating appliance is not intended to be used as a built-in appliance.

 **Warning!** It must be possible to disconnect the appliance from the mains power supply; the plug must therefore be easily accessible after installation. This refrigerating appliance is not intended to be used as a built-in appliance.

## Electrical connection

Before plugging in, ensure that the voltage and frequency shown on the rating plate correspond to your domestic power supply. The appliance must be earthed. The power supply cable plug is provided with a contact for this purpose. If the domestic power supply socket is not earthed, connect the appliance to a separate earth in compliance with current regulations, consulting a qualified electrician.

The manufacturer declines all responsibility if the above safety precautions are not observed. This appliance complies with the E.E.C. Directives.

# Daily use

## First use

Cleaning the interior before using the appliance for the first time, wash the interior and all internal accessories with lukewarm water and some neutral soap so as to remove the typical smell of a brand new product, then dry thoroughly.

**Important!** Do not use detergents or abrasive powders, as these will damage the finish.

## Temperature setting

- Plug on your appliance. The internal temperature is controlled by a thermostat. There are 3 settings. **MIN**, **NORMAL** and **MAX**. **MIN** is warmest and **MAX** is coldest.

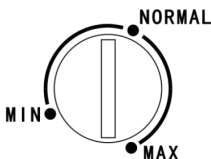

- The appliance may not operate at the correct temperature if it is in a particularly condition hot or if you open the door often.

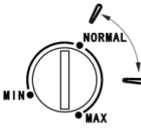
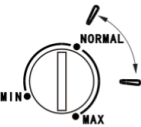
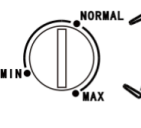
Temperature Setting Recommendation		
Environment Temperature	Freezer compartment	Fridge compartment
Summer		/
Normal		/
Winter		/

*Information above gives users recommendation of temperature setting.*

## Daily use

# Impact on Food Storage

- Under Recommended setting, the best storage time of freezer is no more 1 month.
- The best storage time may reduce under other settings.

Tips for storing frozen food

To obtain the best performance from this appliance, you should:

- make sure that the commercially frozen foodstuffs were adequately stored by the retailer;
- be sure that frozen foodstuffs are transferred from the food store to the freezer in the shortest possible time;
- do not open the door frequently or leave it open longer than absolutely necessary;
- once defrosted, food deteriorates rapidly and cannot be re-frozen;
- do not exceed the storage period indicated by the food manufacture.

## Cleaning

For hygienic reasons the appliance interior, including interior accessories, should be cleaned regularly.

**Caution!** The appliance may not be connected to the mains during cleaning. There is a danger of electrical shock! Before cleaning, switch the appliance off and remove the plug from the mains, or switch off or turn out the circuit breaker or fuse. Never clean the appliance with a steam cleaner. Moisture could accumulate in electrical components, danger of electrical shock! Hot vapors can lead to the damage of plastic parts. The appliance must be dry before it is place back into service.

**Important!** Ethereal oils and organic solvents can attack plastic parts, e.g. lemon juice or the juice for orange peel, butyric acid, cleanser that contain acetic acid.

## Defrosting of the freezer

The freezer compartment will become progressively covered with frost. This should be removed. Never use sharp metal tools to scrape off frost from the evaporator as you could damage it. However, when the ice becomes very thick on the inner liner, complete defrosting should be carried out as follows:

- pull out the plug from the socket;
- remove all stored food, wrap it in several layers of newspaper and put it in a cool place;
- keep the door open, and placing a basin underneath of the appliance to collect the defrost water;
- when defrosting is completed, dry the interior thoroughly;
- replace the plug in the power socket to run the appliance again

# Troubleshooting

 **Caution!** Before shooting any trouble, disconnect the power supply. Only a qualified electrician or competent person must do the trouble shooting that is not in this manual. Important! There are some sounds during normal use (compressor, refrigerant circulation).

Problem	Possible cause	Solution
Appliance does not work	Mains plug is not plugged in or is loose	Insert mains plug.
	Fuse has blown or is defective	Check fuse, replace if necessary.
	Socket is defective	Mains malfunctions are to be corrected by an electrician.
Appliance freezes too much	Temperature is set too cold or the appliance runs at <b>MAX</b> setting.	Turn the temperature regulator to a warmer setting temporarily.
The food is not frozen enough.	Temperature is not properly adjusted.	Please look in the initial Temperature Setting section.
	Door was open for an extended period.	Open the door only as long as necessary.
	A large quantity of warm food was placed in the appliance within the last 24 hours.	Turn the temperature regulation to a colder setting temporarily.
	The appliance is near a heat source.	Please look in the installation location section.
Heavy build-up of frost on the door seal.	Door seal is not air-tight.	Carefully warm the leaking sections of the door seal with a hair dryer (on a cool setting). At the same time shape the warmed door seal by hand such that it sits correctly.
Unusual noises	Appliance is not level.	Re-adjust the feet.
	The appliance is touching the wall or other objects.	Move the appliance slightly.
	A component, e.g. a pipe, on the rear of the appliance is touching another part of the appliance or the wall.	If necessary, carefully bend the component out of the way.

If the malfunction shows again, contact the Service Center. These data are necessary to help you quickly and correctly. Write the necessary data here, refer to the rating plate.

## Helpful hints and tips

To help you make the most of the freezing process, here are some important tips:

- The maximum quantity of food which can be frozen in 24 hours is shown on the rating plate.
- The freezing process takes 24 hours. Add no further food to be frozen during this period.
- Only freeze fresh, top quality, thoroughly cleaned foodstuffs.
- Prepare food in small portions to aid rapid freezing and for thawing only the required quantity.
- Wrap food in airtight packages such as aluminum foil, polythene, or plastic tubs.
- Do not allow fresh, unfrozen food to touch already frozen food to avoid raising its temperature.
- Lean foods store better and longer than fatty ones. Salt reduces the storage life of food.
- Ice lollies could cause skin to freeze-burn, if consumed immediately after removal from the freezer.
- Add a note to date the freezing of food to keep tab of the storage time.

## Freezing fresh food

- The freezer compartment is suitable for freezing fresh food and storing frozen and deep-frozen food for a long time.
- Place the fresh food to be frozen in the bottom compartment.
- The maximum amount of food that can be frozen in 24 hours is specified on the rating plate.
- The freezing process lasts 24 hours: during this period do not add other food to be frozen.

## Thawing

Deep-frozen or frozen food, prior to be used, can be thawed in the fridge compartment or at room temperature, depending on the time available for this operation. Small pieces may even be cooked still frozen, directly from the freezer. In this case, cooking will take longer.

## Ice-cube

This appliance may be equipped with one or more trays for the production of ice-cubes.

# Helpful hints and tips

## Hints for storage of frozen food

To obtain the best performance from this appliance, you should:

- Ensure the commercially frozen foodstuffs were adequately stored by the retailer.
- Ensure that frozen foodstuffs are transferred from store to freezer in the shortest possible time.
- Minimize door opening. Do not leave a door open longer than necessary.
- Once defrosted, food deteriorates rapidly and cannot be re-frozen.
- Do not exceed the storage period indicated by the food manufacturer.

## Defrosting the freezer

It is normal operation for the freezer compartment to become progressively covered with ice. Periodically this should be removed. Never use sharp or metal tools to scrape frost from the evaporator as you could damage it.

If the ice becomes very thick on the inner liner, complete defrosting should be carried out as follows:

- Turn off the power.
- Remove all stored food, wrap it in several layers of newspaper and put it in a cool place.
- Keep the door open. Place a container underneath to collect defrosted water.
- When defrosting is completed thoroughly dry the interior.
- Turn on the power to restart the appliance again.

# Product fiche

MODEL NUMBER	ATTFZ4442W
BRAND NAME	Attimo
PRODUCT DESCRIPTION	Table top Freezer
PRODUCT COLOUR	WHITE
GUARANTEE DURATION IN MONTHS	12
DOOR OPENING DIRECTION	Right hinge, door open from left side
DOOR REVERSIBLE	YES
FREE STANDING	YES
INTEGRATED	NO
UNDER COUNTER	YES
PRODUCT WIDTH	44 CM
COOLING SYSTEM	STATIC
DEFROSTING SYSTEM	MANUAL
CONTROL SYSTEM	MECHANICAL
ANNUAL ENERGY CONSUMPTION - kWh	148
AIRBOURNE ACOUSTICAL NOISE EMISSIONS	40
NOISE LEVEL CLASS	C
STAR RATING	4
ENERGY EFFICIENCY CLASS - NEW STANDARD	E
CLIMATE CLASS	(N) NORMAL (ST) SUB TROPICAL
REFRIGERATING GAS	R600a
CERTIFICATION	CE/GS/CB/PSE
POWER CABLE TYPE	UK
POWER CABLE LENGTH	1.8
VOLTAGE/FREQUENCY	220-240V ~ 50HZ
PACKING TYPE	CARTON (STANDARD)
PACKAGING PRINTED	YES
DOOR HANDLE DESIGN	INTERNAL
FULL METAL BACK	YES
DOOR SEAL COLOR	STANDARD (WHITE)
LED INTERIOR LIGHT	NO
EGG TRAY	NO
ICE TRAY	YES
ACCESSORY COLOUR	white
DOOR BALCONIES	NO
DOOR BALCONIE TRIM	NO
CRISPER DRAWERS	NO
CRISPER DRAWER TRIM	NO
FREEZER DRAWERS	NO
FREEZER DRAWER TRIM	NO
GLASS SHELVES	NO
GLASS SHELVES TRIM	NO
DOOR OPEN ALARM	NO
WATER DISPENSER	NO
HOLIDAY FUNCTION	NO
SUPER FREEZE FUNCTION	NO
ADJUSTABLE LEVELLING FEET	YES
LOGO TYPE	METAL EFFECT
LOGO POSITION	STANDARD
WARRANTY CARD	YES
NAME PLATE LANGUAGE	ENGLISH
PACKAGE LABEL TYPE	STANDARD
PACKAGE LABEL LANGUAGE	ENGLISH
ENERGY LABEL TYPE	STANDARD
ENERGY LABEL LANGUAGE	ENGLISH
EAN CODE	0745125572857
INSTRUCTION MANUAL LANGUAGE	ENGLISH
FRIDGE STORAGE VOLUME NET	0
FREEZER STORAGE VOLUME NET	33
STORAGE TIME DURING POWER-OFF (HOURS)	7.5
FREEZING CAPACITY IN 24 HOURS (KG)	2.4
NET WEIGHT (KG)	14
GROSS WEIGHT (KG)	15.5
PRODUCT DIMENSIONS W X D X H (mm)	440 x 475 x 515
PACKAGING DIMENSIONS W X D X H (mm)	460 x 490 x 528
LOADING CAPACITY - 40HC	599

# Help & assistance

If you require any technical guidance or find that your fridge freezer is not operating as intended, a simple solution can often be found in the Troubleshooting section of these instructions or online at [www.altimo.co.uk](http://www.altimo.co.uk)

If you still require further assistance, call one of our experts on **0330 041 7490**. To help us give you a fast and efficient service please have the following information ready:

Model Ref.	<input type="text"/>	<i>You can find these on the rating plate - a small information panel (usually a sticker or metal plate) on the rear of your appliance.</i>
Serial number	<input type="text"/>	
Date of purchase	<input type="text"/>	<i>This will be shown on your receipt.</i>

Local call rates apply\*

**Lines open 9.00am-5:00pm Monday to Friday.**

\*Calls to enquiry lines may attract a charge and set up fee from residential lines depending on your call plan/tariff. Mobile and other providers costs may vary, see [www.bt.com/pricing\\_for\\_details](http://www.bt.com/pricing_for_details).

For Security and training purposes, telephone calls to and from customer service centres may be recorded and monitored. Calls from Republic of Ireland will attract international call charges.

# Your Appliance Guarantee Guarantee Details (UK only)

Your appliance has the benefit of a comprehensive manufacturer's guarantee which covers the cost of repair due to mechanical or electrical breakdown.

Any claim during the period of the guarantee must be accompanied by proof of purchase. The appliance must be correctly installed and operated in accordance with the manufacturer's instructions.

Your appliance is intended for normal domestic use and not for commercial operations. This guarantee does not cover cosmetic issues with the appliance or failures caused by accidental damage, misuse or alternations which are likely to affect the appliance.

The guarantee is invalid if the product is tampered with or repaired by any unauthorised person.

What to do if you need to report a problem:

1. Please ensure you have ready:
  - The product model **ATTFZ4442W** and serial number
  - Your full contact details
2. Call the specialist Service Line for your product: 01759 487835

This guarantee in no way affects your statutory or legal rights.

Any information provided to us for the purposes of product support is subject to our privacy policy, which can be viewed online at [www.altimo.co.uk/privacy-policy](http://www.altimo.co.uk/privacy-policy)



[www.altimo.co.uk](http://www.altimo.co.uk)

For customer service call: 0330 041 7490