



## Instruction Manual



**60cm Cooker Hood**

**SCH601W / SCH601B / SCH601SS**



# Contents

<b>1</b>	<b>TECHNICAL DRAWING</b>	<b>4</b>
<b>2</b>	<b>WARNING AND SAFETY PRECAUTIONS</b>	<b>5</b>
	2.1 LETHAL RISK, DANGER OF POISONING	7
<b>3</b>	<b>USING WITH OR WITHOUT A CARBON FILTER</b>	<b>10</b>
<b>4</b>	<b>CARBON FILTER REPLACEMENT</b>	<b>11</b>
<b>5</b>	<b>CLEANING AND PREVENTIVE MAINTENANCE</b>	<b>12</b>
	5.1 ALUMINIUM FILTER CLEANING	13
	5.2 WASHING YOUR FILTER IN A DISHWASHER	13
	5.3 WASHING YOUR FILTER BY HAND	13
<b>6</b>	<b>APPLIANCE POSITIONING</b>	<b>14</b>
	6.1 UNPACKING THE APPLIANCE	14
	6.2 ENERGY SAVING AND EFFICIENT USE	14
<b>7</b>	<b>PACKAGE CONTENTS</b>	<b>15</b>
<b>8</b>	<b>ASSEMBLY OF YOUR PRODUCT</b>	<b>16</b>
<b>9</b>	<b>OPERATION</b>	<b>17</b>
<b>10</b>	<b>REPLACING THE LAMPS</b>	<b>18</b>
<b>11</b>	<b>AUTHORISED SERVICE</b>	<b>19</b>
<b>12</b>	<b>TECHNICAL TABLE</b>	<b>20</b>
<b>13</b>	<b>PRODUCT SUPPORT</b>	<b>20</b>
<b>14</b>	<b>YOUR APPLIANCE GUARANTEE</b>	<b>21</b>

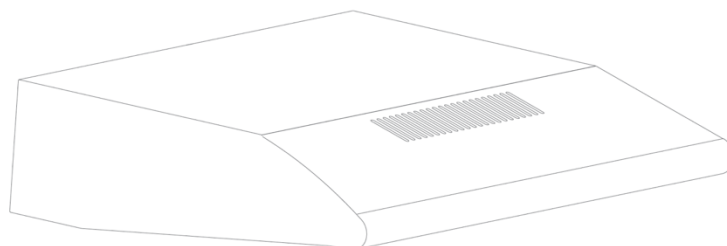

# 1 TECHNICAL DRAWING

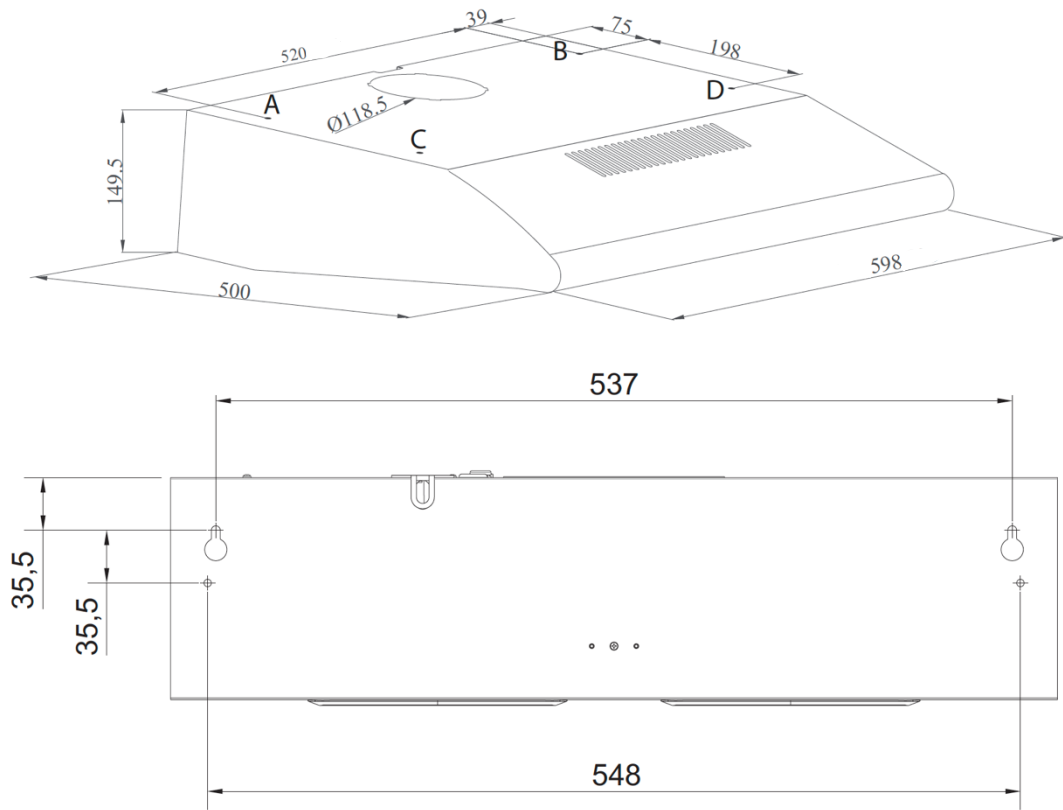

Fig. 1

## 2 WARNINGS AND SAFETY PRECAUTIONS

### WARNINGS AND SAFETY PRECAUTIONS

This appliance can be used by children of 8 years and older, people with physical, sensory or mental capability deficiency or people with lack of experience or knowledge; as long as they are provided supervision or instructions for the safe use of the appliance and they comprehend the dangers.

- Children should not tamper with the appliance. Cleaning and user maintenance operations must not be performed by children unless supervised.
- This product is designed for home use.
- Usage voltage of your product is 220-240 Volt~50-60 Hz.
- Power cable of your product is fitted with a grounded plug. This cable must be plugged into a grounded outlet.
- All electrical wiring must be installed by a qualified electrician.
- Installation should be carried out by a competent person. Failure to do so could lead to poor operational performance, damage to the product, and accidents.
- The power supply cable to the appliance must be carefully routed. Take care not to jam the cable or leave it exposed. The power cable must be safely routed away from heat sources to avoid melting, a possible cause of exposure and risk of fire.
- Do not plug in the appliance before the installation is complete.
- Make sure that the installation method allows a user to easily unplug the power cable in case of a need to isolate the unit.
- Do not touch the lamps when they are in use as they can get very hot and could lead to burning.
- Domestic kitchen hoods are designed and manufactured for normal domestic household use. They are not intended for extended, heavy duty or commercial use. Doing so increases risk of malfunction and product guarantee will be void.
- Comply with the guidelines and rules regarding the discharge of air, as stipulated by the relevant authority. (This warning does not apply to recirculation without flue).
- Do not cook flammable foods under the appliance.
- Start your hood at the same time as you start cooking to avoid a build-up of heat that may cause some parts of your product to deform.
- Turn off the heat source before taking the saucepan or pan off the cooker.
- Do not leave oil on a heat source unattended. Pans containing boiling oil can catch fire.
- Use care when cooking with hot oils as they can ignite badly positioned cloth.
- Ensure you keep filters clean and regularly replaced. Build-up of accumulated grease deposits increase the likelihood of malfunction and fire risk.
- Do not use unspecified filter materials as in place of genuine parts for operational and safety reasons.
- Do not operate your product without a filter and do not remove the filters when the product is in operation.

## WARNING AND SAFETY PRECAUTIONS

- In case of fire, isolate the power to the hood and any other cooking devices. (unplug the appliance or turn off at the main switch).
- Keep your product clean. Build-up of deposits can increase the risk of fire.
- Isolate the appliance before any maintenance operations. (Unplug the appliance or turn off at the main switch.)
- When extracting air using an electric cooker hood or other devices operating simultaneously, the negative pressure in the room must not exceed 4 Pa (4 X 10 bar). Ensure adequate ventilation.
- Care and attention must be observed when using this appliance simultaneously with other appliances affecting ambient air. By its nature of discharging ambient air in a limited environment this hood could adversely affect the levels of air increasing risk of combustion. Items to be considered include burners of gas, diesel, coal, wood, burning heaters, and shower heaters. This warning applies to discharged air only and does not apply to re-circled uses without flue. Gas or fuel oil burning appliances, such as room heaters, which share the same environment with your product, must be fully insulated from the exhaust of this product or they must be hermetical.
- When connecting a flue to your product use ducting pipes with a diameter of 150mm or 120mm. Minimise both the length and number of connections to the outside to promote good flow and improved operation.
- Children must not play with the appliance.
- For your safety use a fuse rated 'MAX 6A' for your hood.
- Handle and dispose of packaging materials safely, as they pose a risk keep them away from children.
- Any damage to the power supply cable must be replaced by the manufacturer, an authorised service location or any other qualified person, to avoid any dangerous situation.
- In case of fire, isolate the cooker hood and cooking appliances, cover the flame with a damp cloth. Never use water to extinguish the fire.
- When cooking appliances are in operation accessible parts could be hot.
- This appliance is not intended to be used by people with physical, sensory and mental disabilities (including children) or those who have not adequate experience and knowledge regarding its use, unless they are under the supervision of a person responsible for the safety of the appliance.
- It is a requirement that installation of the hood must provide minimum distance of 65cm between the bottom surface of the hood and any electric cook top and 75cm between any gas ranges or cookers burning other fuels.
- Output air must be ducted unique to this product, do not connect to shared air ducts.

## 2.1 LETHAL RISK, DANGER OF POISONING



### **DANGER! Warning - Choking Hazard**

The packaging materials are dangerous for children. Never allow children to play with packaging materials.



### **DANGER! Warning - Death Hazard**

Danger to life and danger of poisoning due to reabsorbed combustion gases.

When used in extraction mode (via ducting) you must ensure there is adequate ventilation for sufficient fresh air. Do not use this hood in extraction mode simultaneously with devices that discharge toxic gases through flue such as ventilated gas, oil, wood or coal burning heaters, shower heaters or water heaters, unless you have provision for fresh inlet air. (Fig. 2)

Ventilated goods (e.g. gas, oil, wood or coal burning heaters, shower heaters, water heaters) take combustion air from their installation location and discharge the waste gases through a waste gas system (e.g. flue). When the cooker hood is active, by nature it removes air from the kitchen and adjacent rooms. Unless adequate fresh air is provided a vacuum is created and with it a risk of toxic gases being taken back in the room from the waste flue of any of these units. (Fig. 2)

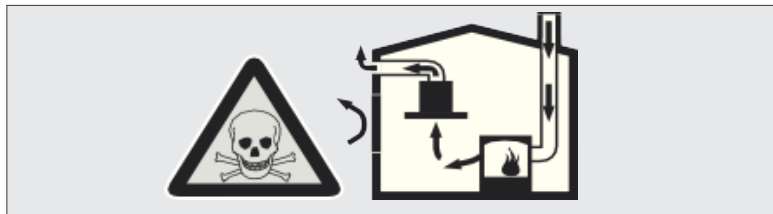

*Fig. 2: Poisoning Danger*

Therefore, it is imperative adequate fresh air ingress is confirmed. (Fig. 3)

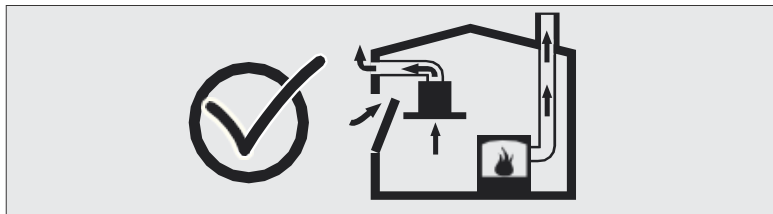

*Fig. 3*



**WARNING!**

**Fire danger!**

- **Clean the oil filter at least every 3 months.**
- Build-up of oily residue from poor cleaning regime will lead to an increased fire risk.
- Never operate the device without an oil filter.
- Oil residue is captured in the filter during operation therefore creating increased fire risk. Other activities exacerbating the risk should be avoided, for example never work with an open flame such as flambe near the device.
- This unit is suitable for use near a solid fuel (e.g. wood or coal) heater, provided any unit has a non-removable cover preventing any sparks from escaping.
- Hot oils and fats catch fire easily and should never be left unattended.
- Never try to put out a fire with water. Always turn off the cooker first then smother the flames carefully using a fire blanket, damp tea towel or similar material.
- Operating a cooking zone without a saucepan or pot in place creates higher heat that can damage your cooker hood, especially in the case of gas. Turn off the heat before removing the pan.
- Operating multiple gas burners simultaneously creates high heat, which can damage your hood. Never operate two or more gas zones longer than 15 minutes on a high flame setting. A large burner over 5kW (Wok) has the power of two gas burners.



**WARNING!**

**Electrocution hazard!**

- Never use a malfunctioning electrical item. If your hood appears to be operating incorrectly turn off the device straight away by isolating the power or removing the 13a plug from the socket, then contact customer service.
- Unsuitable repairs pose hazards. Repairs and replacement parts, including power cords, must be provided by Altimo approved technicians or other trained individuals.
- Do not use copious amounts of water to clean your hood. High pressure or steam cleaners must not be used. Risk of electric shock.



**WARNING!**

**Risk of burn, risk of electric shock!**

- Allow the appliance to cool down after use before cleaning or performing maintenance tasks. It is good to isolate the power or remove the 13a plug from the socket before starting.
- Do not clean the control panel or switch area with a wet cloth as moisture can damage electrical components.
- Do not use aggressive and/or abrasive cleaning agents. Select the right product, the surface of your hood could be damaged by using unsuitable agents.
- For stainless steel surfaces, clean only their brushing direction. Do not use stainless steel cleaner on the control panel or switch area.



**WARNING!****Dangers of fire and physical injury!**

Do not use an adapted or non-authorized repair. Do not make repairs or modifications to the design of your product. Repairs must be performed by authorized trained individuals. Spare parts must be original as designed.

**NOTICE!**

If your hood appears to be faulty or damaged, stop use, turn off, isolate the power or remove the 13a plug from the socket and contact customer service.

**NOTICE!**

No not use your hood with a damaged power cable. If the power supply cable is damaged for any reason it must be replaced by an authorized repair agent or trained individual.

**NOTICE!**

Replace the defective bulbs swiftly to protect the remaining bulbs against overloading. Turn off the unit, isolate or remove the 13a plug from the socket before removing the spent bulb (leave bulbs to cool down first). Ensure the replacement bulb is of the same type and values.

**CAUTION!**

Surfaces and components of items around cooking devices get very hot in use.

**DANGER!**

The air outlet of this hood must not be connected into any flue shared by other devices that use gas or other burned fuels.

**CAUTION!**

Damage hazard due to corrosion.

When cooking, always operate the cooker hood to minimise the condensation formation from pans. A repeated build-up of condensates can lead to corrosion damage.

Moisture intrusion near electronic parts should be avoided. Never clean the control area with a wet cloth as the electrical switches could be damaged.

Mitigate the possibility of damage caused by condensate liquid backflow by installing the ducting with a slight downward inclination (1°) from the appliance.

### 3 USING WITH OR WITHOUT A CARBON FILTER



You can use this appliance in extracted air mode or recirculated air mode.

#### Extracted air mode

The cooking air is cleaned by grease filters and is discharged outside through ducting. (Fig. 4)



#### NOTICE!

Exhaust air must not be sent via an active smoke or waste gas flue; or a flue used for ventilation of places where heat sources are installed.

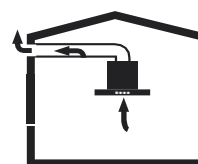

Fig. 4: Air Outlet without Carbon Filter

- If you wish to transfer exhaust air to an inactive smoke or waste gas flue, you must obtain authorization from a specialist.
- Exhaust air must travel without break to an external grill or cowl.

#### Recirculated air mode

Cooking air is cleaned in two stages, first a grease filter and secondly an (optional) active carbon filter. Then filtered air is transferred back to the kitchen. (Fig. 5)



#### **Active Carbon Filter**

*Discs of carbon are used in the path of airflow to help trap and hold the substances within cooking air responsible for bad smells.*

*Carbon Filters in all hoods should be changed regularly (guide 6 months), depending on use.*

*Consult your local dealer or visit [www.altimo.co.uk](http://www.altimo.co.uk)*

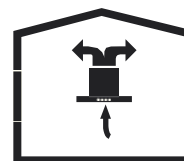

Fig. 5: Air Circulation with Carbon Filter



The model number of your hood is on the front of these instructions. The part number for the carbon filters required for this hood is Altimo CF001

Supplied in a pack of two (as two required)

## 4 CARBON FILTER REPLACEMENT

Although it is always preferable to duct cooking air outside, in some room settings this is not possible. This is the method to use if you have no access to use an outside flue and instead want to clean and recycle air. During this method air is filtered first through the grease filter and then through a pair of (optional) carbon filters.

From the factory this hood is set as standard to extract air using ducting, if you have no access to ducting and want to use the product to recycle air you will need to follow the steps below to prepare the unit for recirculation mode by changing an air guide and adding a pair of (optional) carbon filters.

1. Carefully remove the aluminium cartridge filters from the bottom of the hood. (set them down safely as they will be re-fitted shortly)
2. Using a Philips screwdriver remove the long air deflector on the motor case (Fig. 6).
3. In place of the long air deflector you have just removed, install the short version of the air deflector (found in the installation accessories). (Fig. 7).
4. Place the carbon filter in its housing (Fig. 8). Rotating the carbon filter clockwise, ensure that it has a good fit.
5. In a twisting motion fix the round blanking plate to the flue outlet on the top surface of the hood (Fig. 9).

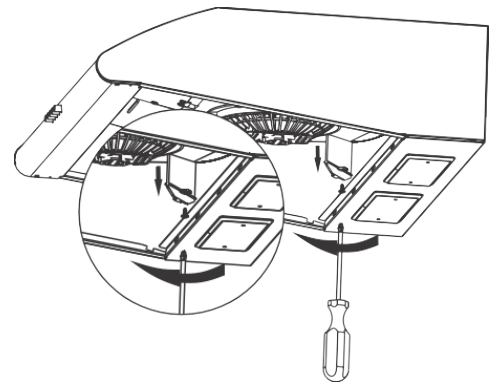

Fig. 6

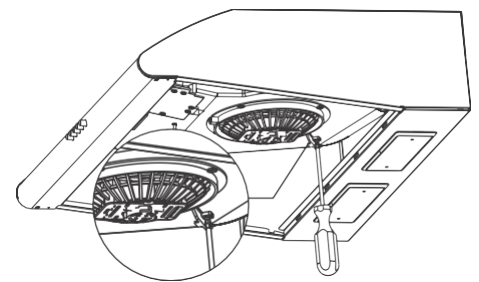

Fig. 7: short deflector

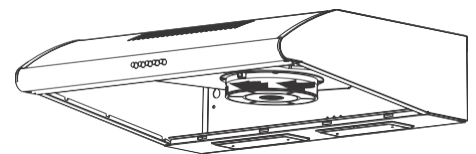

Fig. 8

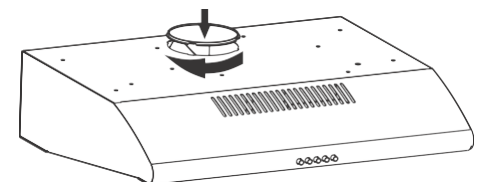

Fig. 9



*Ensure the carbon filter is snugly fitted to prevent it dropping out of position and damaging your hood.*



### **DANGER!**

Never wash the carbon filters.

Keep carbon filters away from children.

## 5 CLEANING AND PREVENTIVE MAINTENANCE



### CAUTION!

Cleaning and user maintenance of the appliance should not be performed by unattended children.

- Do not use aggressive or abrasive cleaning agents as these could damage your appliance. Take extra care around the switches and finished surfaces as these are more sensitive to scratching.
- Clean the surfaces with a soft damp cloth with dish washing liquid or mild glass cleaning agent. Soften tough to clean areas with a damp cloth but do not scrape.
- Do not use abrasive dry cloths, scourers or abrasive agents such as sand, acid or chlorine as these could damage your unit.
- Clean any stainless-steel surfaces only in their brushed finish direction to avoid permanent marking.
- Do not use wet cloths on or around the control unit.
- Do not use stainless-steel or abrasive cleaning agents in or around the control unit.
- Clean the metal grease filters regularly, depending on usage. The metal grease filters are designed to capture the greasy particles in the moisture and vapours generated when cooking. It is recommended to clean the metal grease filters about every three months under normal use and conditions (guide of 1 to 2 hours use a day).
- Do not use excessively effective, acidic or alkaline cleaning agents.
- During the cleaning of your metal grease filters is an ideal opportunity to clean around the metal grease filter holder too. A cloth damp with washing up liquid and water mix is suggested.
- It is possible to clean the metal grease filters by hand or in your dishwasher (although some discoloration may appear over time).
- To avoid damage do not to apply cleaning products directly to the product.
- Do not keep flammable and/or heavy decorative items on your hood.

## 5.1 ALUMINIUM FILTER CLEANING

To remove the aluminium grease filter first locate the opener tab (1) and press it gently sideways against its spring in the direction shown (2). Then pull the filter away from the hood gently in the direction of the arrow as shown (3) (Fig. 10).

As you remove the aluminium filter, hold it with your other hand to prevent it from dropping.

Take care as you remove the filter as it is likely to be greasy and slippery. Take care to keep it parallel to the floor to prevent accumulated oil from dripping on the floor.

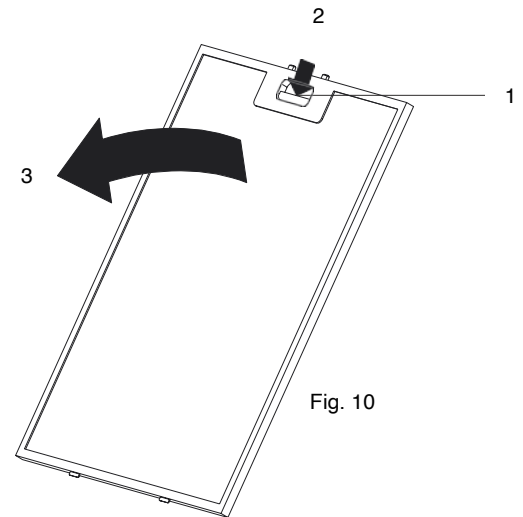

Fig. 10

## 5.2 WASHING YOUR FILTER IN A DISHWASHER

It is possible to wash the metal grease filter in a dishwasher. This can be very effective but could lead to a slight discoloration of the aluminium over time. This has no effect on the function of the metal grease filter.

- Wash very dirty metal grease filters separately to avoid contamination with other items.
- For best results position your grease filters in your dishwasher with space around them for better cleaning.

## 5.3 WASHING YOUR FILTER BY HAND



*For heavy duty cleaning seek a specialist grease solvent from a specialist sales centre.*

- *Soften the metal grease filters in a hot water with dishwashing liquid.*
- *Use a brush for cleaning and wait for the liquid in metal grease filters to flow off completely.*
- *Rinse the filters thoroughly after cleaning.*

## 6 APPLIANCE POSITIONING

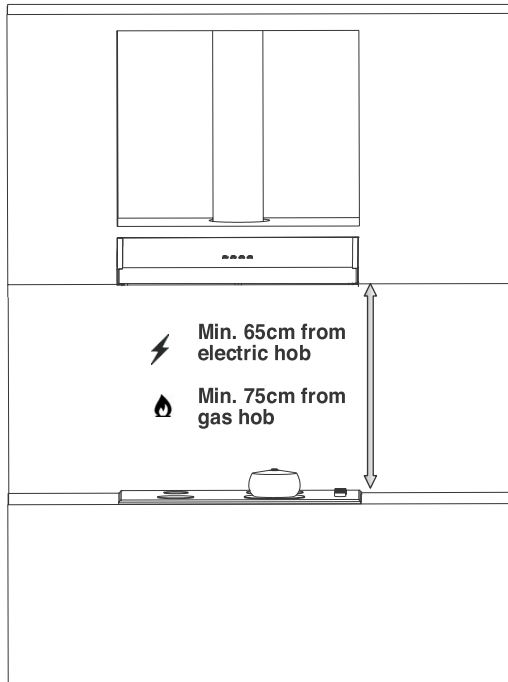

Fig. 11

The final installed position of the hood must exceed the minimum required distance (Fig. 11).

The minimum distance between the bottom of the hood and a gas (or other burning fuel) cook top is 75cm.

The minimum distance between the bottom of the hood and an electric cook top must be at least 65cm.

### 6.1 UNPACKING THE APPLIANCE

- Check over your new appliance for damage.
- Check that you have all contents shown in section 7.
- Do not install or use a damaged unit. Please advise the carrier and supplying dealer straight away.
- NEVER allow children to play with packaging materials

### 6.2 ENERGY SAVING AND EFFICIENT USE RECOMMENDATIONS

- Keep the hood clean.
- Regularly clean your metal grease filters to maintain good air flow, promoting lower speeds.
- Replace the carbon filters on a regular basis to reduce odours.
- Ducting should have the shortest distance with few turns.
- Use the lowest practical fan speed for most efficient energy consumption.

## 7 PACKAGE CONTENTS

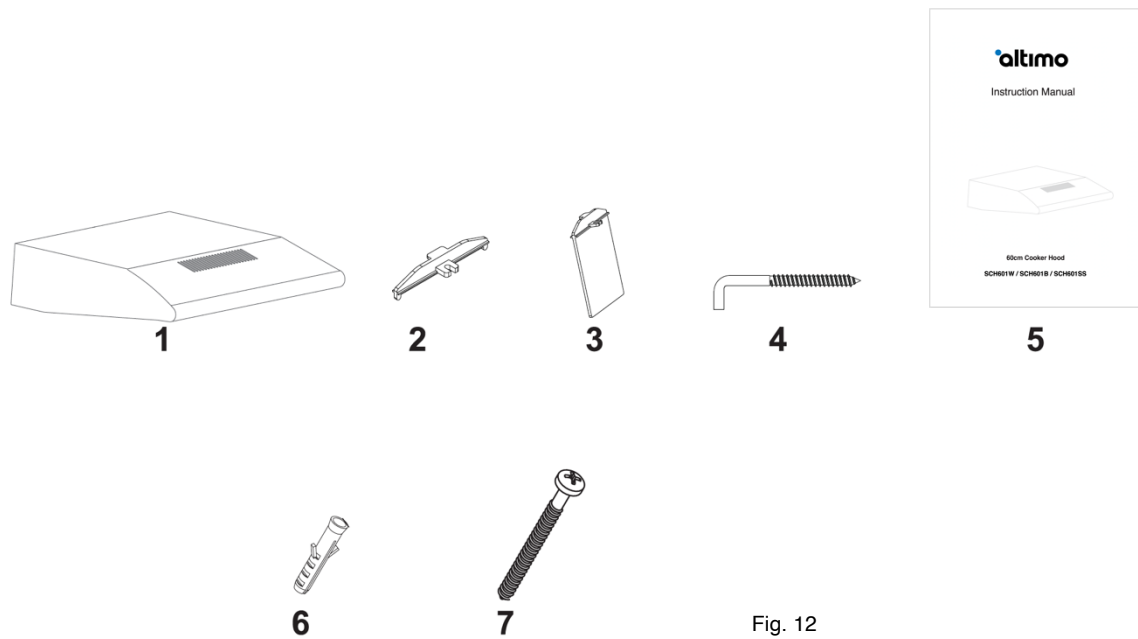

Fig. 12

- 1 Product
- 2 Short Air Deflector (for recycled air mode)
- 3 Long Air Deflector (fitted from factory)
- 4 Hanging Hook (x2)
- 5 User Manual
- 6 2x Ø10mm Wall Plug
- 7 4x 4x40 Screw

## 8 ASSEMBLY OF YOUR PRODUCT

This is a suggested installation. All kitchens are different. If you are unsure, please consult with a trained person.

1. Remove the aluminium grease filter and place to one side.
2. Offer up the intended position of your hood and mark the two fixing points on the rear of the hood (shown as E and F on Fig. 13) also the four fixing points on the top of the hood (shown as A B C D on Fig. 14)
3. Drill holes on the points E & F that you have marked, insert the wall plugs and screw in the two hanging hooks.
4. Hang your appliance over the L shaped hanger screws (at points E, F that you have installed) and then use the supplied four screws up at corner points A, B, C, D (Fig. 14).
5. Install the plastic collar found in the installation accessories to the duct exit of the product. Line up the tabs on the plastic collar with the tabs on the duct exit and turn in clock- wise direction (Fig. 15).
6. Perform the flexible flue connection of your appliance (Fig. 16).

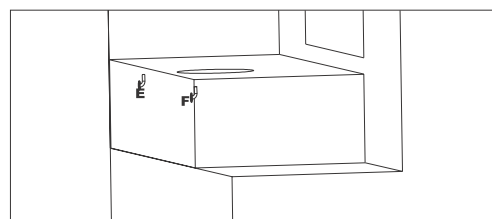

Fig. 13

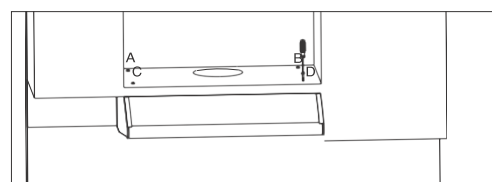

Fig. 14

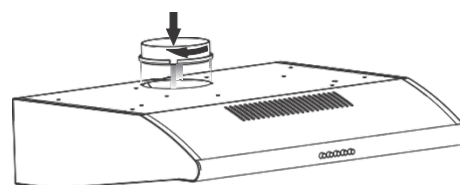

Fig. 15

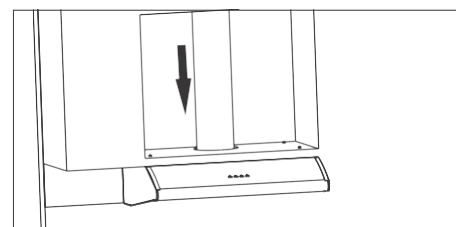

Fig. 16



*Flexible flue is easy to use but for best results minimise twists and bends to maximise performance.*



## 9 OPERATION

### How to use the push button controls

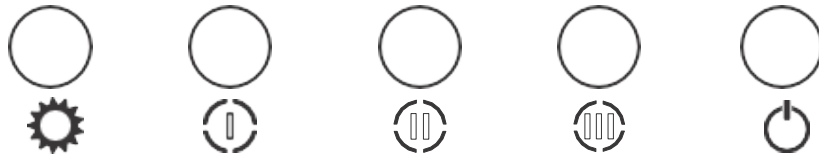







Fig.17: Push buttons

	Off
	Fan speed 1
	Fan speed 2
	Fan speed 3
	Light on and off

# 10 REPLACING THE LAMPS

## Lamp replacement



### WARNING!

Disconnect the electrical supply of the hood. Leave the lamps to cool down first to avoid the risk of burning.



**max 28 W**

It indicates the maximum power consumption of the lamp. A lamp with same power rating should be used when replacing the lamp.



*The original bulb power rating can be found on the product information panel.*

### To replace the bulb:

1. Remove the aluminium grease filters.
2. Remove the faulty bulb and replace with a new one with the same rating. (Fig. 18)

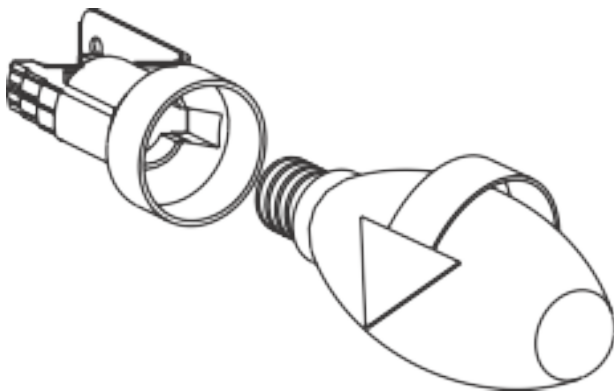

Fig.18: Lamp Replacement

# 11 AUTHORISED SERVICE

## Possible fault remedies to try before calling Customer Care:

### No light:

- If the fan is working check the bulbs:  
Firstly, isolate the power before following the instructions for how to change a bulb.  
Tighten the bulbs as they may be loose, replace the bulbs if necessary.

### No light or fan:

- Is the plug in and the switch on?
- Has the RCD tripped? If yes, turn it back on.
- Has a fuse blown? Replace the fuse.

### Poor performance:

- Is the ducting a sufficient diameter? (Min 125mm).
- Are the metal grease filters clean? Please check.
- If you are using recycling mode (without ducting) check the carbon filters are not older than 6 months.
- If you have converted your hood to recycle air instead of ducting out, did you change the air deflector from large to small?
- Ensure you have inlet air. If your kitchen area is sealed without fresh air this will impair air flow. Open a window or door.

If you are not satisfied with your hood, please contact Altimo Customer Care.

## Troubleshooting

Fault description	Problem area to check	Remedy
Product does not work	Check the power connection.	Mains voltage must be 220-240v and plugged into an earth (grounded) socket.
Illumination lamp does not operate	Check the power connection.	Mains voltage must be 220-240v and plugged into an earth (grounded) socket.
	Check the lamp switch.	Lamp switch must be at "on" position.
	Check the bulbs.	Bulbs may need replacing. If one bulb is working the other is loose or blown.
Product's air Intake is weak	Check the metal grease filter.	The aluminium cartridge filter should be washed regularly for best results.
	Check the air outlet.	Check the ducting is free flowing.
	Check the carbon filter.	If you are using the hood to with carbon filters, they must be replaced regularly to remain efficient.
Product does not discharge air (in recycle mode)	Check the metal grease filter	The metal grease filter should be washed regularly to maintain good efficient air flow.
	Check the carbon filter	If fitted the carbon filters must be replaced periodically (suggested once in every 3-6 months under normal conditions).

## 12 TECHNICAL TABLE

Supply Voltage	220 - 240 V 50Hz
Insulation Class of Motor	F
Insulation Class	CLASS I



This product complies with the 2014/30/EC (Regulation on Electromagnetic Compliance) and 2014/35/EC (Regulation on Low Voltage Devices (LVD)) Directives.



This device complies with the Directive on the Control of Waste Electrical and Electronic Equipment. Specifications of the device and this manual may be modified without prior notification.

## 13 PRODUCT SUPPORT

We want you to be happy with your hood.

If you have a concern, question or need a repair please contact Altimo customer service:

- **Telephone** 0330 041 7490 during business hours
- **Email** [customerservice@altimo.co.uk](mailto:customerservice@altimo.co.uk)
- **Web** [www.altimo.co.uk](http://www.altimo.co.uk)

# 14 YOUR APPLIANCE GUARANTEE

## Guarantee Details (UK only)

Your appliance has the benefit of a comprehensive manufacturer's guarantee which covers the cost of repair due to mechanical or electrical breakdown.

Any claim during the period of the guarantee must be accompanied by proof of purchase.

The appliance must be correctly installed and operated in accordance with the manufacturer's instructions.

Your appliance is intended for normal domestic use and not for commercial operations.

This guarantee does not cover cosmetic issues with the appliance or failures caused by accidental damage, misuse or alternations which are likely to affect the appliance.

The guarantee is invalid if the product is tampered with or repaired by any unauthorised person.

What to do if you need to report a problem:

1. Please ensure you have ready:
  - The product model and serial number
  - Your full contact details
2. Call the specialist Service Line for your product: **0330 041 7490**

This guarantee in no way affects your statutory or legal rights.

Any information provided to us for the purposes of product support is subject to our privacy policy, which can be viewed online at:  
[www.altimo.co.uk/privacy-policy](http://www.altimo.co.uk/privacy-policy)



[www.altimo.co.uk](http://www.altimo.co.uk)

For customer service call: 0330 041 7490